



E-mail: distributor@hyggeraquarium.com

Website: www.hyggeraquarium.com



HG039 USER MANUAL

hygger manual aquarium gravel cleaner

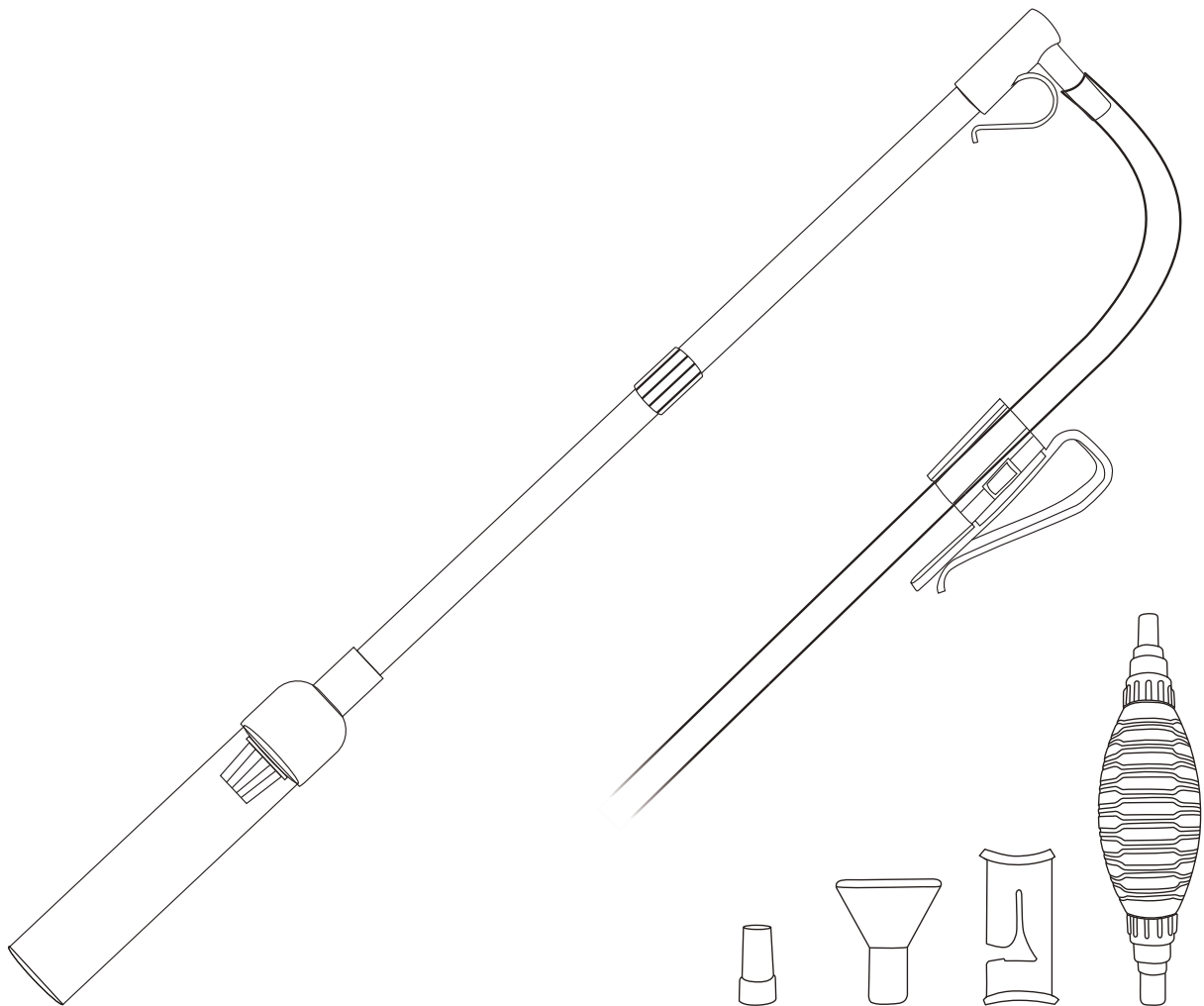

Hygger Aquarium Manual Gravel Cleaner is a siphon tool used for water change, sand washing and dirt suction. Our products make it easier to clean debris hidden in the substrate or floating in the water.

Please read this user manual carefully before using and follow it strictly.

Note: The gravel cleaner requires a 19.7-inch vertical drop from the water inlet to the water outlet, and the minimum water level of the tank should be 6 inches before changing water.

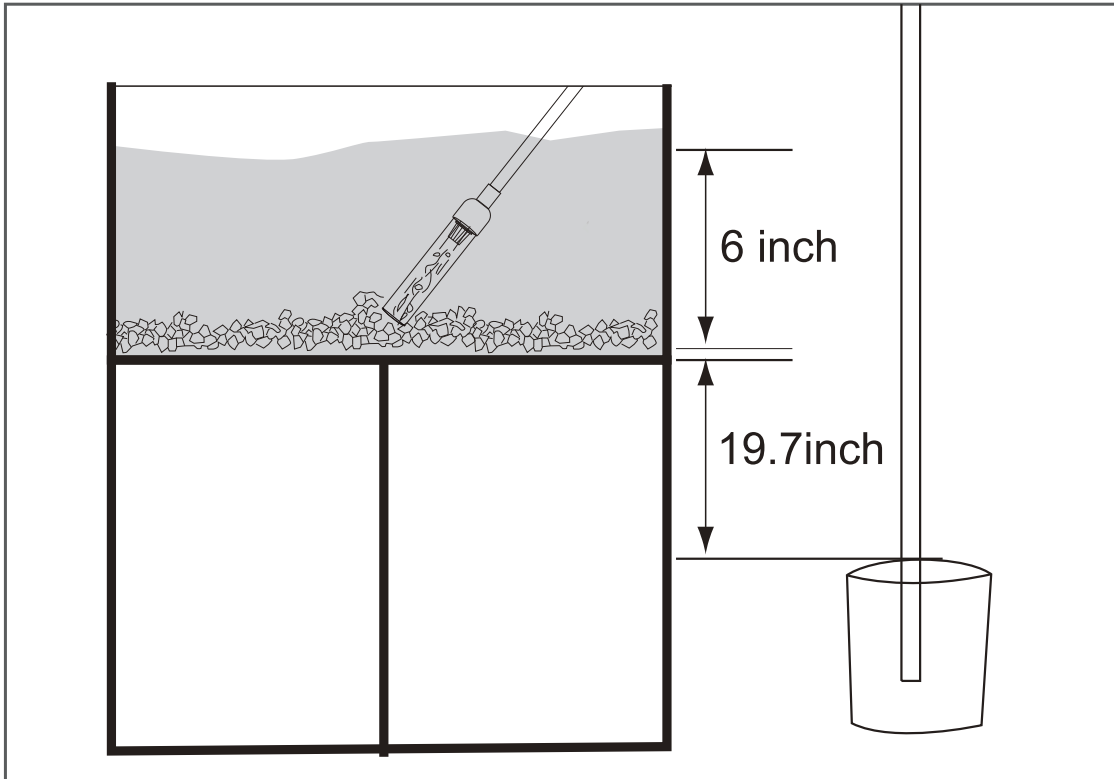

1. PRODUCT FEATURES

- (1) **Multi-function:** The gravel cleaner can be used for water change, sand washing, dirt suction.
- (2) **Suitable for various tanks:** This aquarium gravel cleaner comes with two extended hard tubes and a 78.7-inch outlet hose. The total length is 19.7 inches (S) or 31.5 (M). With the hose, the S-size product can be extended from 15.6 inches to 25.4 inches, which makes it suitable for fish tanks with a depth of no more than 24 inches. (The M-size product can be extended from 23.6 inches to 39.4 inches, which makes it suitable for fish tanks with a depth of no more than 38 inches.)
- (3) **Durable suction ball:** The suction ball is made of high-quality and durable EVA material.
- (4) **Easy installation:**
 - ① Connect the suction ball with the tube and press the suction ball several times until the outlet tube is full of water.
 - ② Loosen the suction ball. The water will flow out automatically.
 - ③ Equipped with a flow control valve and hose clamp. (The hose at the outlet can be hung on the bucket, and the water flow can be adjusted freely)
- (5) **Powerful vacuum:** It has enough power to clean every corners of the tank without wetting hands and quickly drain dirty water.

2.PRODUCT DIAGRAM

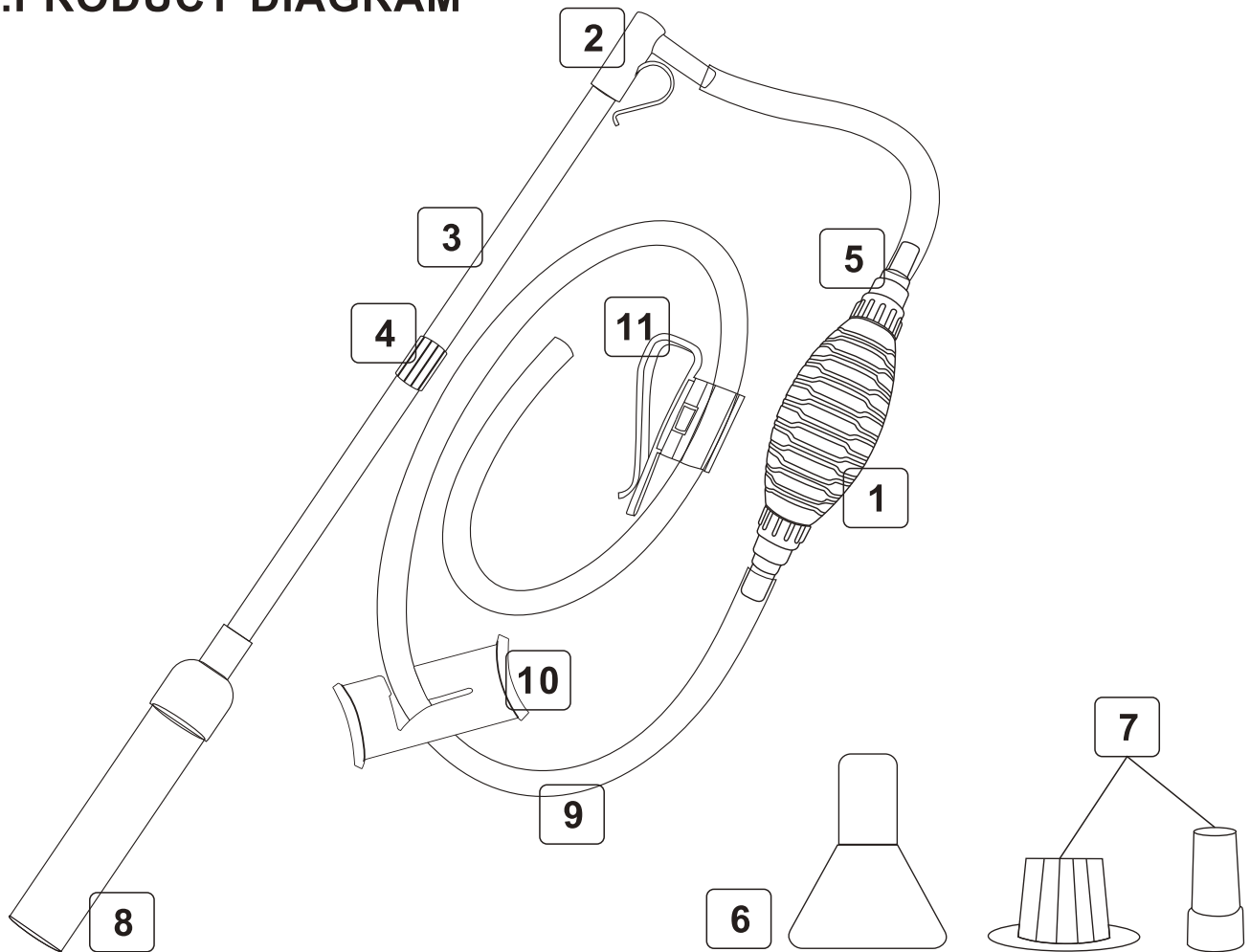

- | | | |
|----------------------|----------------------------------|--------------------------|
| (1) Suction ball | (5) Components of the inlet tube | (8) Gravel cleaning tube |
| (2) Portable handle | (6) Duck bill | (9) Water outlet hose |
| (3) Hard tube | (7) Filter basket | (10) Flow control valve |
| (4) Hard tube joints | (11) Hose clamp | |

3.INSTALLATION INSTRUCTIONS

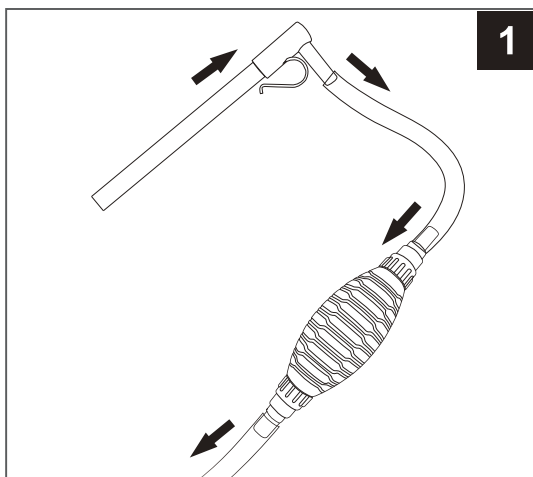

(1) Connect the suction ball to the outlet hose and the portable handle. The other interface of the portable handle is connected to the hard tube.

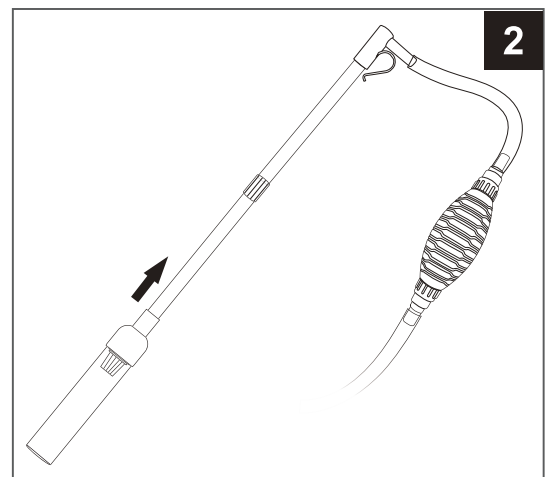

(2) Connect the inlet kits and the gravel cleaning tube.

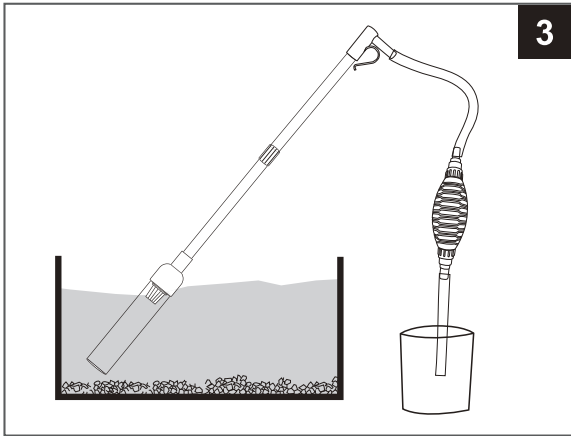

(3) Put the inlet tube into the aquarium, and put the outlet tube into the bucket.

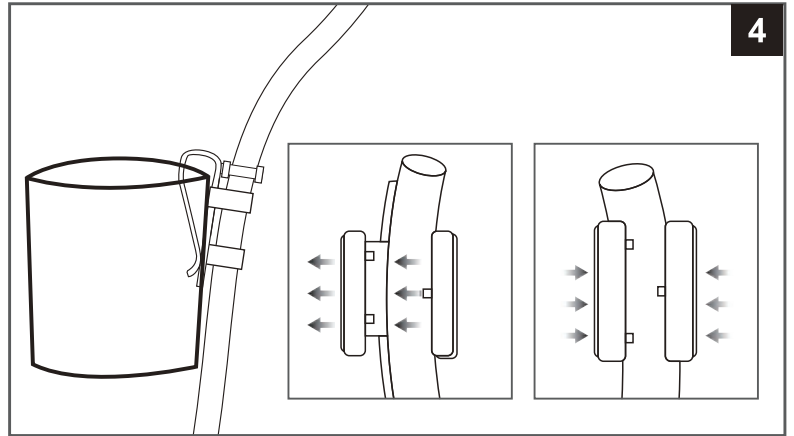

(4) Clamp the outlet tube to the bucket to prevent the outlet hose from falling off.

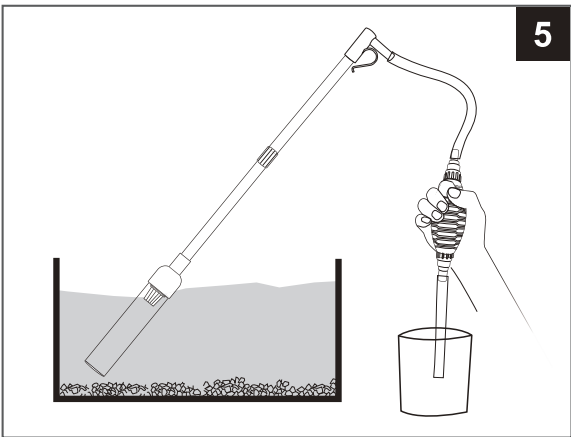

(5) Press the suction ball several times until the outlet tube is full of water, and then loosen the suction ball, the water will automatically flow out.

(**Tips:** If the outlet tube is not full of water, do not insert the gravel cleaning tube into the substrate unless there is water flowing out from it.)

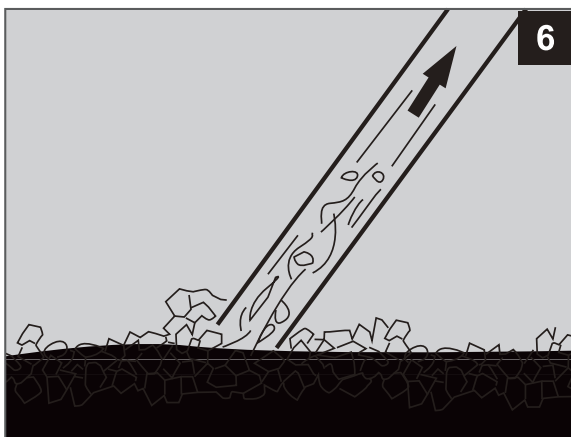

(6) Insert the gravel cleaning tube into the substrate. It will suck the sand or gravel and lift it up and down to remove the dirt and clean the water.

Tips:

- ① Use the flow control valve to slow down the water flow. Clamp the flow control valve to the outlet hose when in use.
- ② The vacuum cleaner can also help remove dirt if your tank is not equipped with a substrate. You just need to insert the cleaner into the inlet tube.
- ③ Hard tube can be extended with the joint to adapt to different tanks of different heights.

4.ATTENTIONS:

- ✓ Please read this user manual carefully before using and follow it strictly.
- ✓ Please keep it away from children.
- ✓ The water outlet must be 19.7 inches lower than the water inlet when you use this gravel cleaner.
- ✓ Please check for air leakage when connecting the tube.
- ✓ Please clean the internal garbage regularly.
- ✓ Do not use the gravel cleaner in flammable and corrosive liquid.
- ✓ Do not use the water changer in too hot or too cold water (temperature above 36°C or under 0°C). It will damage the material.

5.PACKING LIST

- | | |
|-----------------------------|-----------------------------|
| (1) 1x Suction ball | (7) 2x Filter basket |
| (2) 1x Portable handle | (8) 1x Gravel cleaning tube |
| (3) 2x Hard tubes | (9) 1x Outlet hose |
| (4) 1x Hard tube joint | (10) 1x Flow control valve |
| (5) 1x Inlet tube component | (11) 1x Hose clamp |
| (6) 1x Duck bill | (12) 1x User manual |

6.ONE YEAR LIMITED WARRANTY

This product **MUST** be purchased from an authorized hygger reseller. Visit our website for a list of unauthorized resellers. Hygger warrants this product against defects in materials and workmanship for **ONE(1) YEAR** from the date of the original retail purchase and is none-transferable.

Warranty on all products, including aquariums. But it is limited to the replacement of the products and does not cover fish loss, personal injury, property loss or direct, incidental or consequential damage caused by using this product.

Note: Hygger One-year Limited Warranty does not cover damage caused by the followings: improper installation, saltwater corrosion, electrical surges or modifications.

If you discover a defect, please contact hygger, who will, at it's option, repair or replace the product at no charge, provided that you return it during the warranty period. A copy of the bill of sale is required as a proof of the original purchase date in the event of the product needing repairs within the warranty period. Hygger does not warrant any products that are not hygger's.

This warranty does not apply if the product has been damaged by accident, abuse, misuse or misapplication, or modified without the written permission of Hygger.

7. CONTACT INFORMATION

Brand owner : Shenzhen Mago Trading Co., Ltd

Add : Bantian Group Business Central , Longgang District, Shenzhen City , Guangdong Province , China

E-mail: distributor@hyggeraquarium.com

Website: www.hyggeraquarium.com



MADE IN CHINA