



E-mail: distributor@hyggeraquarium.com

Website: www.hyggeraquarium.com



HG107 USER MANUAL

hygger saltwater aquarium light

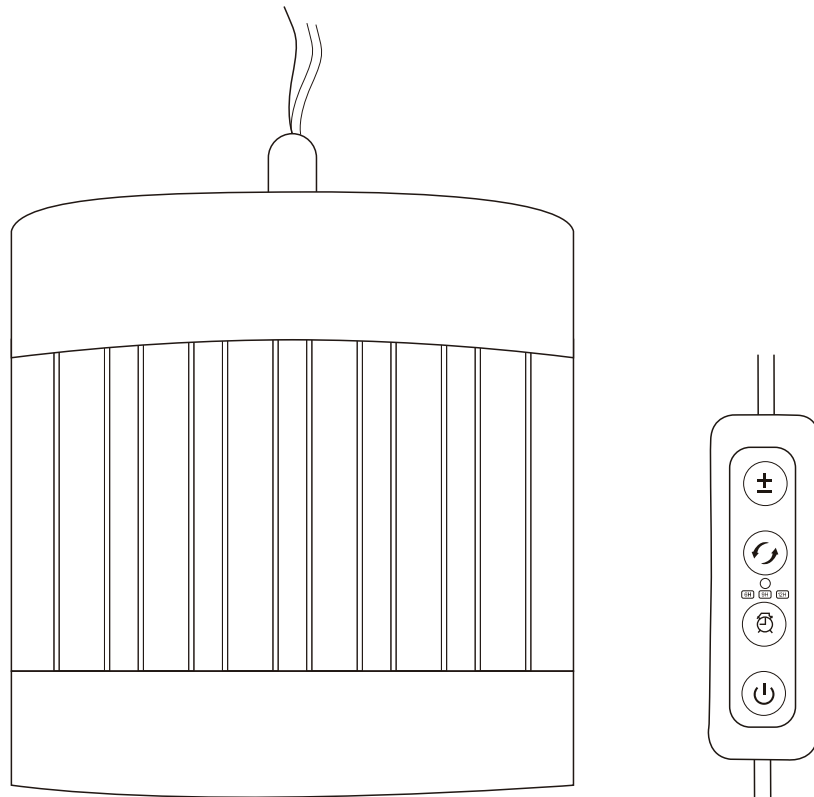

hygger saltwater light is a good choice for aquariums, and is specifically designed for LPS corals and soft coral reef tanks. Please read this manual carefully before use and follow the instructions carefully.

1.PRODUCT FEATURES

- **Full spectrum aquarium light:** Light promotes optimal coral growth, enhances coral’s vibrant colors, and creates a soft glow throughout the aquarium.
- **Smart fan for light temperature control:** The integrated fan effectively dissipates excess heat, maintaining an optimal light temperature.
- **Adjustable Light Height:** By lengthening or shortening the line on the light, and adjusting the height of the bracket to determine the appropriate light height.
- **Suitable for tanks less than 0.80 inches thick:** This LED aquarium light is compatible with most rimmed and rimless tanks with glass up to 0.80 inches thick.

2.PRODUCT PARAMETERS

Model	Output Voltage	Power	Led Quantity	Light Size	Suitable Tank Size	Power Cord
HG107	DC24V	50W	56PCS	3.70" (9.4cm)	24"X24"x24" (61cm x61cm x61cm)	4.92ft+2.96ft (1.5m+1m)

3.PRODUCT DETAILS

① bracket ② bracket ③ bracket

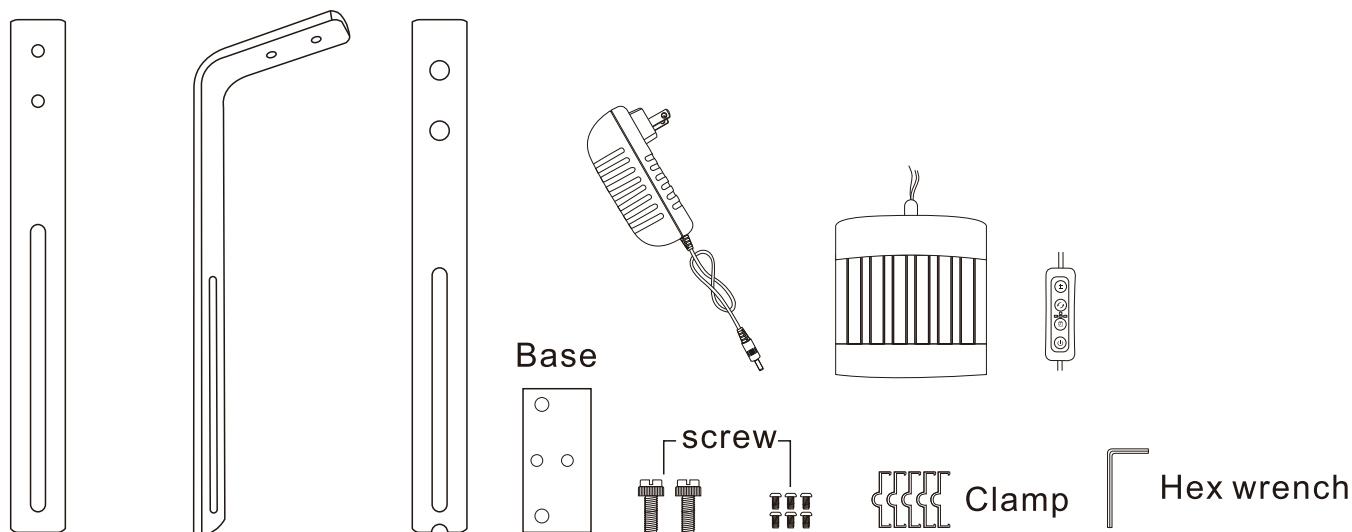

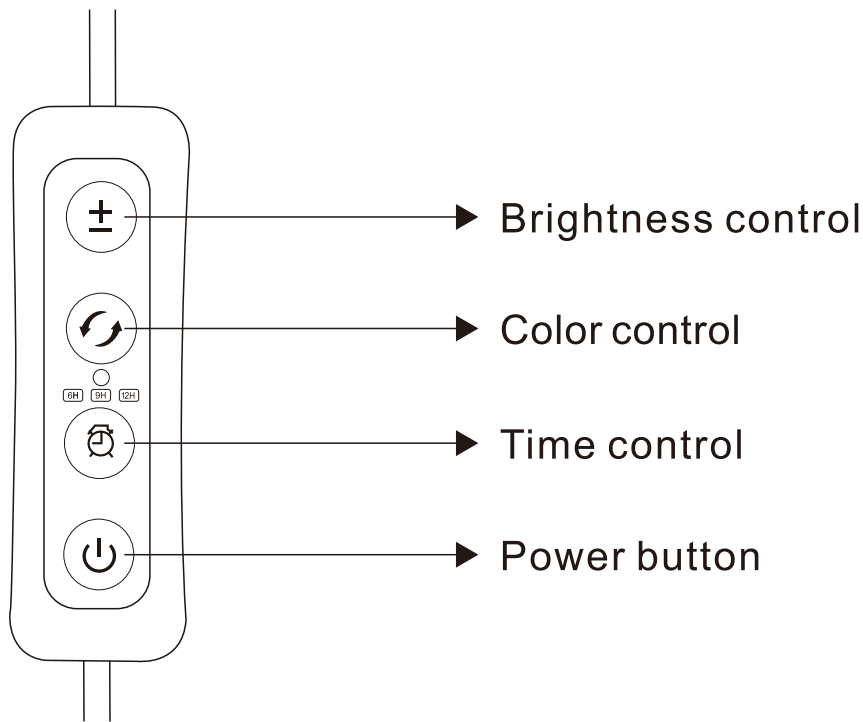

4. INSTALLATION INSTRUCTION

- 1) Take products and accessories out of the package.
- 2) Install screws ① on the base, take ① bracket, align the end of the band gap with the two holes of the base, and screw down with screws ②.

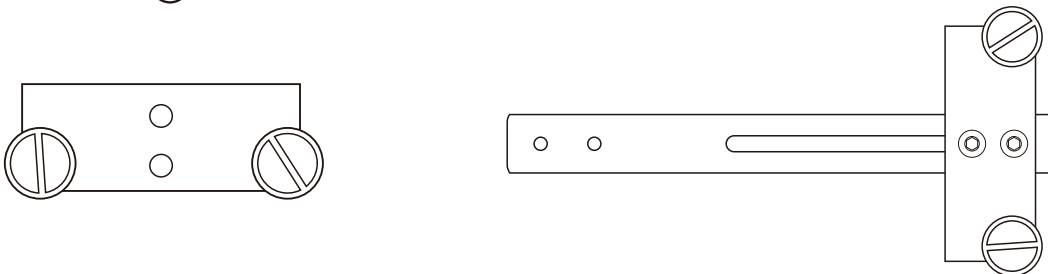

- 3) Connect ② bracket, align the gap of ② bracket with the screw holes of ① bracket, adjust the required length, and screw down with screws.

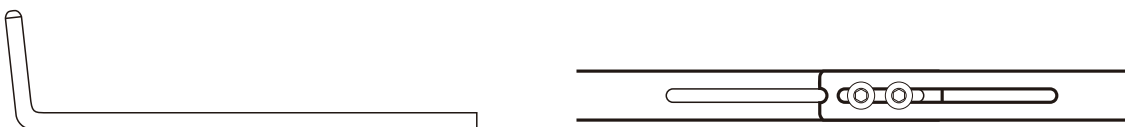

- 4) Take the ③ bracket, and attach the screw holes of the ② bracket to the screw holes of the ③ bracket and screw down with screws ③.



- 5) Loop the wire on the light through the gap in the bracket, adjust to a suitable length, and tighten the wire lock with a screw.

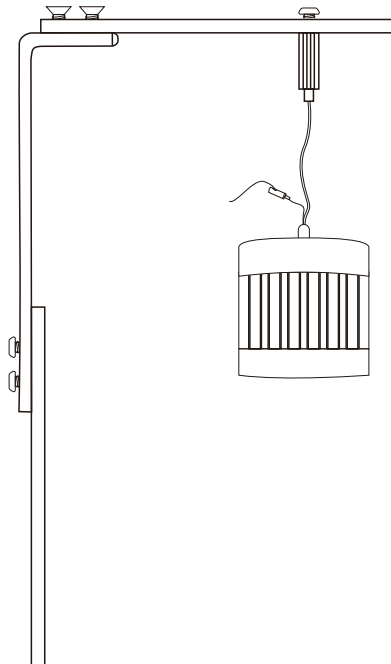
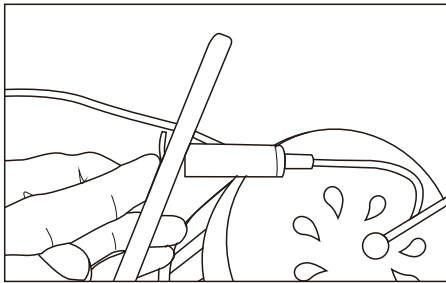
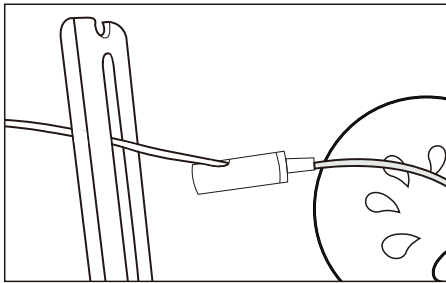

- 6) Run the wire around the bend of the bracket head and secure the wire and lamp wire with clamps.

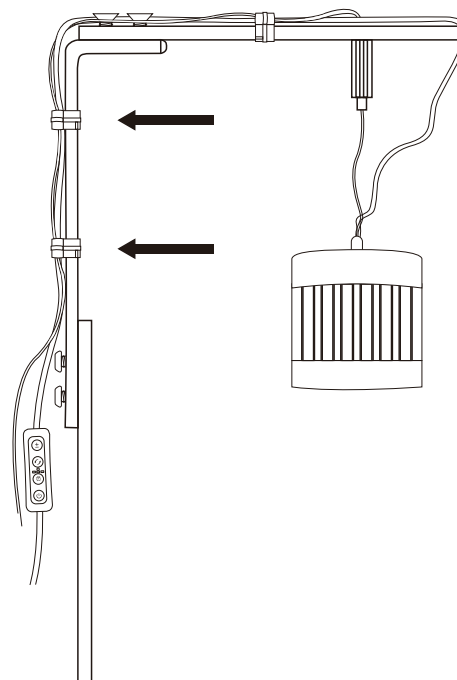
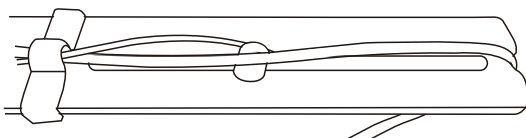

7) Connect the extension cable for the light and the extension cable for the power adapter.

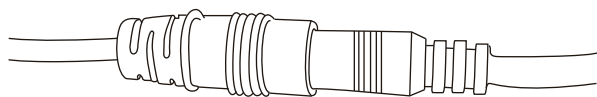

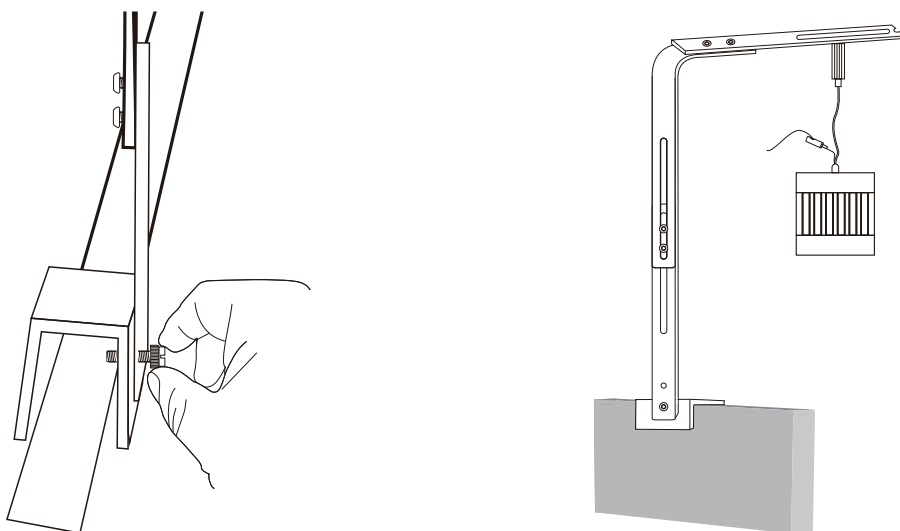

8) Loosen the base knob to match the tank thickness and install it securely in the fish tank.



9) Finally, plug in the power supply and select the desired light settings.

5. OPERATION METHOD

- The light offers five levels of brightness adjustment: 100% --77% --55% --32% --10%, cycling from the darkest to the brightest. It also offers three color options: blue, white, and warm white. Additionally, you can set the duration of the light with three time settings: 6H, 9H, and 12H.

- DIY mode setting:  Press the “color setting” button to set the desired color. After the color setting is completed, press the “brightness” button  to adjust the brightness. Finally, press the “time” button  to set the desired time. The light will come on according to the color, brightness and time you set.

Attention: When you press the “6H”, the indicator is yellow, and “9H” is green, “12H” is red.

6H timing: The yellow light on the controller indicates that the 6-hour timing mode is on, and the cycle is 24 hours. The light will work according to the set color and brightness for 6 hours and then turn off automatically and turn on at the same time the next day.

9H timing: The green light on the controller indicates that the 9-hour timing mode is on for a 24-hour cycle. The light will work according to the set color and brightness for 9 hours and then turn off automatically and turn on again at the same time the next day.

12H timing: The red light on the controller indicates that the 12-hour timing mode is on for a 24-hour cycle. The light will work according to the set color and brightness for 12 hours and then turn off automatically and turn on again at the same time the next day.

6. WARNING

To avoid possible electrical shock, do not immerse the switch in water. If the switch falls into the water or otherwise becomes wet, do not touch it until you have unplugged it. Basic safety precautions should be observed including the following:

1. Read and follow this user manual strictly.

2. DANGER-To avoid possible electric shock, special care should be taken. For each of the following situations, do not attempt to repair yourself; return the light to an authorized service facility for service or discard the light.

A. Carefully examine the light after installation. It should not be plugged in if there is water on parts not intended to be wet.

B. Do not operate the light if it has a damaged cord or plug, if it is malfunctioning or if it is dropped or damaged in any manner. The power cord of this light cannot be replaced, if the cord is damaged, the light should be discarded.

C. To avoid the possibility of the light plug getting wet, position the aquarium stand and tank to one side of a wall-mounted receptacle to prevent water from dripping onto the receptacle or plug. A “drip loop”, shown in the figure below, should be arranged by the user for each cord connecting the light to the receptacle. The “drip loop” is the part of the cord below the level of the receptacle or the connector. If an extension cord is used, to prevent water from traveling along the cord and coming in contact with the receptacle. If the plug or receptacle does get wet, DO NOT unplug the cord. Disconnect the fuse to the circuit breaker that supplies power to the light. Then unplug and examine for the presence of water in the receptacle.



3. Close supervision is necessary when the light is used near children.

4. To avoid injury, do not touch moving or hot parts.

5. Make sure the light is securely installed before operating it.

6. Read and observe all the important notices on the light.

7. If an extension cord is necessary, a cord with a proper rating should be used. A cord rated for less amperes or watts than the appliance rating may overheat. Care should be taken to arrange the cord so that it will not be tripped over or pulled.

8. The light is intended FOR HOUSEHOLD USE ONLY.

9. SAVE THIS USER MANUAL.

7. ONE YEAR LIMITED WARRANTY

This product **MUST** be purchased from an authorized hygger reseller. Visit our website for a list of unauthorized resellers. hygger warrants this product against defects in materials and workmanship for **ONE(1) YEAR** from the date of the original retail purchase and is non-transferable.

Warranty on all products, including aquariums. But it is limited to the replacement of the products and does not cover fish loss, personal injury, property loss, or direct, incidental, or consequential damage caused by using this product.

Note: hygger One-year Limited Warranty does not cover damage caused by the followings: improper installation, saltwater corrosion, electrical surges or modifications. Additionally, products that have been refunded are also not covered under the warranty.

If you discover a defect, please contact hygger, who will, at it's option, repair or replace the product at no charge, provided that you return it during the warranty period. A copy of the bill of sale is required as a proof of the original purchase date in the event of the product needing repairs within the warranty period. hygger does not warrant any products that aren't hygger's.

This warranty does not apply if the product has been damaged by accident, abuse, misuse or misapplication, or modified without the written permission of hygger.

8. DISPOSAL

Do not dispose of this product as unsorted municipal waste. Collection of such waste separately for special treatment is necessary. This product has to be disposed of at an authorized place for the recycling of electrical and electronic appliances rather than being disposed of together with the domestic waste. Collecting and recycling waste is a way of saving natural resources. So, please consult with your local seller to make sure the product is disposed of in an environmentally friendly way.

9. PACKING LIST

1x User manual
1x Light
1x Power adapter
1x Controller
3x Clamp(2 spare parts)
3x Bracket
8x Screw
1x Hex wrench
1x Base

10. CONTACT INFORMATION

Distributed by: Hygger Aquarium, Inc.
13941 Magnolia Ave, Chino, CA 91710

E-mail: distributor@hyggeraquarium.com

Website: www.hyggeraquarium.com

Trademarks of Shenzhen Mago Trading Co.,Ltd
Bantian Group Business Center, Longgang,
Shenzhen City, China
All Rights Reserved

Made in China

EC	REP
-----------	------------

E-CrossStu GmbH
Mainzer Landstr.69, Frankfurt am Main,
Baden-Württemberg, 60329, Germany
E-CrossStu@web.de
+49 69332967674

UK	REP
-----------	------------

YH Consulting Limited
C/O YH Consulting Limited Office
147, Centurion House, London Road,
Staines-upon-Thames, Surrey,
TW18 4AX, London
H2YHUK@gmail.com
+44 07514-677868

